

HECPM

General Operating, Maintenance and Installation Manual



DIN-Rail Embedded PC / Profibus Master



IPCOMM GmbH

Gundstraße 15
91056 Erlangen
Germany

Phone: +49 9131 92076-0
Fax: +49 9131 92076-10
Internet: <http://www.ipcomm.de>
Email: info@ipcomm.de

Edition September 2010
Version 1.0.4



DIN EN ISO 9001:2008
Zertifikat: 01 100 040757

1 Contents

1	CONTENTS.....	1
2	INTRODUCTION	2
3	DEVICE PRESENTATION	3
3.1	Rail-mounted Embedded PC HEC.....	3
3.2	Nomenclature.....	3
3.3	Operation.....	4
3.4	Mounting and Dismounting	5
3.5	Electrical Installation – Circuit Diagram.....	6
3.6	Maintenance	7
3.7	CPU-Status LED.....	9
3.8	PROFIBUS-DP Master diagnostics LEDs.....	10
3.9	Scope of Delivery.....	10
4	APPENDIX A – TECHNICAL DATA SHEET	11
5	APPENDIX B – DECLARATION OF EEC COMPLIANCE	14

2 Introduction

All technical information, specifications and illustrations contained in this Operating, Maintenance and Installation Manual remain our property and shall not be used otherwise than for operating this installation, nor shall they be copied, reproduced or passed on to third parties or brought to their notice without our prior written consent.

The information represented in this manual is in keeping with current standards and is subject to later alterations.

This manual contains important instructions referring to safe installation, commissioning, operation and maintenance.

Read this manual carefully before starting up the DIN-Rail Embedded PC (HECPM) - also called as DIN-Rail Mounted PC - and observe the instructions.

It is to be noted that the HECPM has not been protected against lightning and the operator should, *if desired*, take appropriate protective precautions.

Caution!

The HECPM is a class A device. This device can cause radio disturbances in residential buildings. In this case the operator might be obliged to carry out appropriate measures and take responsibility.

At this point we want to draw your attention to the fact that any warranties with respect to the delivered goods will be invalid in the event that:

- (1) Operation, servicing and maintenance are not carried out accurately according to the instructions; repairs are not carried out by our personnel or without our prior written consent.
- (2) Commissioning is not carried out by our personnel or we have not given our approval for the commissioning or the commissioning is carried out by untrained personnel.
- (3) The unit is used inadequately, incorrectly, negligently or inappropriately or for a purpose other than that originally intended.
- (4) The serial number is removed from the product.

3 Device Presentation

3.1 Rail-mounted Embedded PC HEC

The rail-mounted PC HEC has been specially designed for industrial applications and serves as hardware platform for the protocol converter

The HEC basic version is fitted with a PC/104 CPU module and offers serial RS232 interfaces as well as an Ethernet adapter.

The rail-mounted PC contains no rotating components. Thanks to the low power requirements a cooling fan is not necessary. A Compact Flash memory card with an MTBF $\geq 1.000.000$ h serves as a storage medium.

Integrated LEDs support various diagnosis functions. Indicators for the input voltage, send and receive status of the RS232 interfaces and the network controller report the current operating status.

A CAN controller can be installed directly on the PC/104 CPU module. In addition, the rail-mounted PC can be upgraded with various PC/104 modules and thus integrated in various fieldbus systems.

3.2 Nomenclature

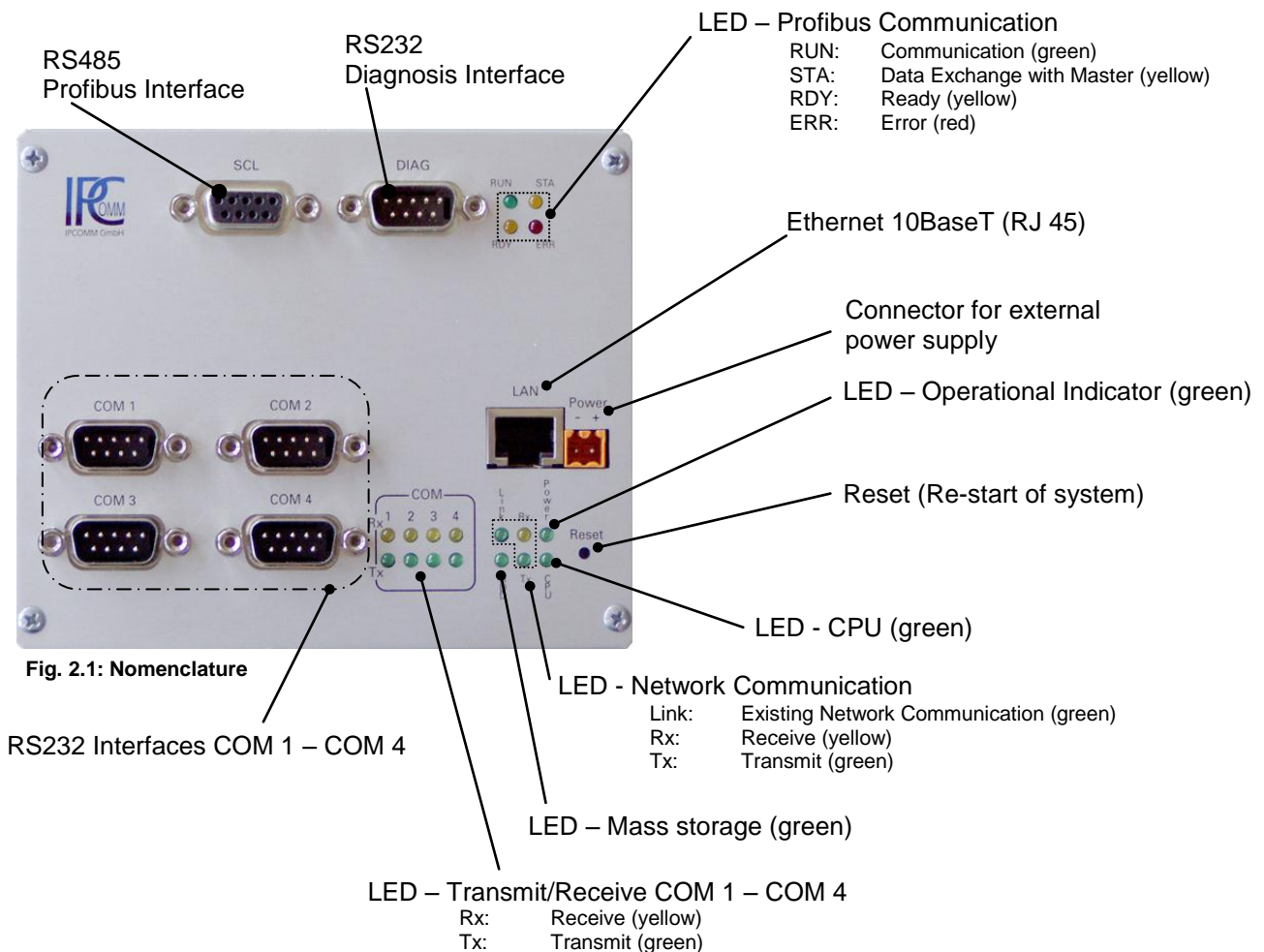

Fig. 2.1: Nomenclature

RS232 Interfaces COM 1 – COM 4

3.3 Operation

The HECPM is designed for the assembling on a 35 mm DIN-Mounting Rail.

The HECPM is supplied with 18 - 36 V DC.

In order to maintain operation large temperature fluctuations must be avoided. The HECPM mustn't be exposed solar radiation.

An air-conditioned environment is to be recommended for operating the HECPM. Interference sources like power inverters and power cables close to the HECPM should be avoided.

The following operating conditions are to be observed for interference-free operation:

- Environmental temperature: 0°C – 45°C
- Relative humidity: 5 % - 90 % **non-condensing**
- Installation site and environmental conditions should comply with the corresponding degree of protection (IP 40).
The housing isn't protected against the penetration of water!
- The supply voltage (see label) must correspond with the stated operational data.
It must be ensured that excessive voltage fluctuations in the power supply are avoided.
- Mounting on electro conductive and grounded DIN-Mounting Rail.

Note: Excessive voltages affecting the HECPM directly via the supply voltage or indirectly via data lines, power line or flashovers might cause damage to the HECPM.
Interference of this kind must be prevented.

Important: If a external power supply is delivered by IPCOMM GmbH the instructions can be found in the enclosed operating manual.

Further operating instructions depend on the kind and number of the installed components and on the operating system. The relevant information can be found in the project-specific or product-specific manual.

The operating and control elements are located on the front side, Fig. 2.1.

3.4 Mounting and Dismounting



Abb. 2.3.1: Assembling

A minimum distance D_{min} need be observed if several HECPMs are to be installed in a row.

The assembling has to be occurred in accordance with Figure 2.3.1

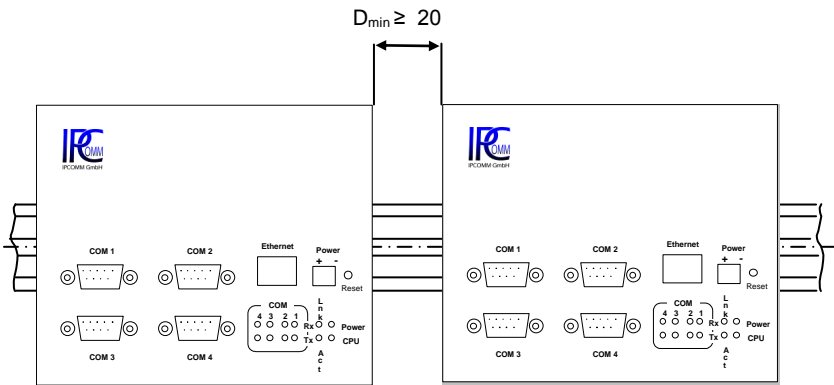
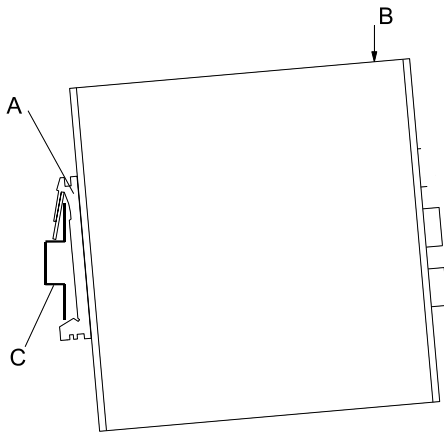

Fig. 2.3.2: Mounting

The HECPS is mounted on a 35 mm DIN-Mounting Rail.

As per Figure 2.3.2 opposite, clip A is put on to the DIN-Mounting Rail C.

By pressing in the direction of the marked point B the HECPM snap into place.

The ground connection is completed via clip A directly to the DIN-Mounting Rail.

It must be ensured that the DIN-Mounting Rail is electro conductive and grounded.

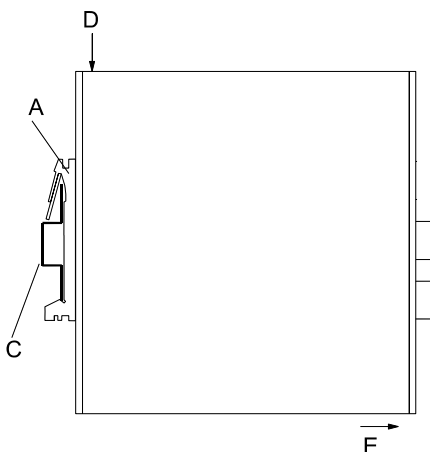

Fig. 2.3.3: Dismounting

For dismounting, press in the direction of the marked point D while pulling at the bottom of the HECPM in direction E, Fig. 2.3.3.

3.5 Electrical Installation – Circuit Diagram

The HECPM must be connected as per the following circuit diagram, Fig. 2.4.

Dependent on the application the circuit may be different from the shown one.

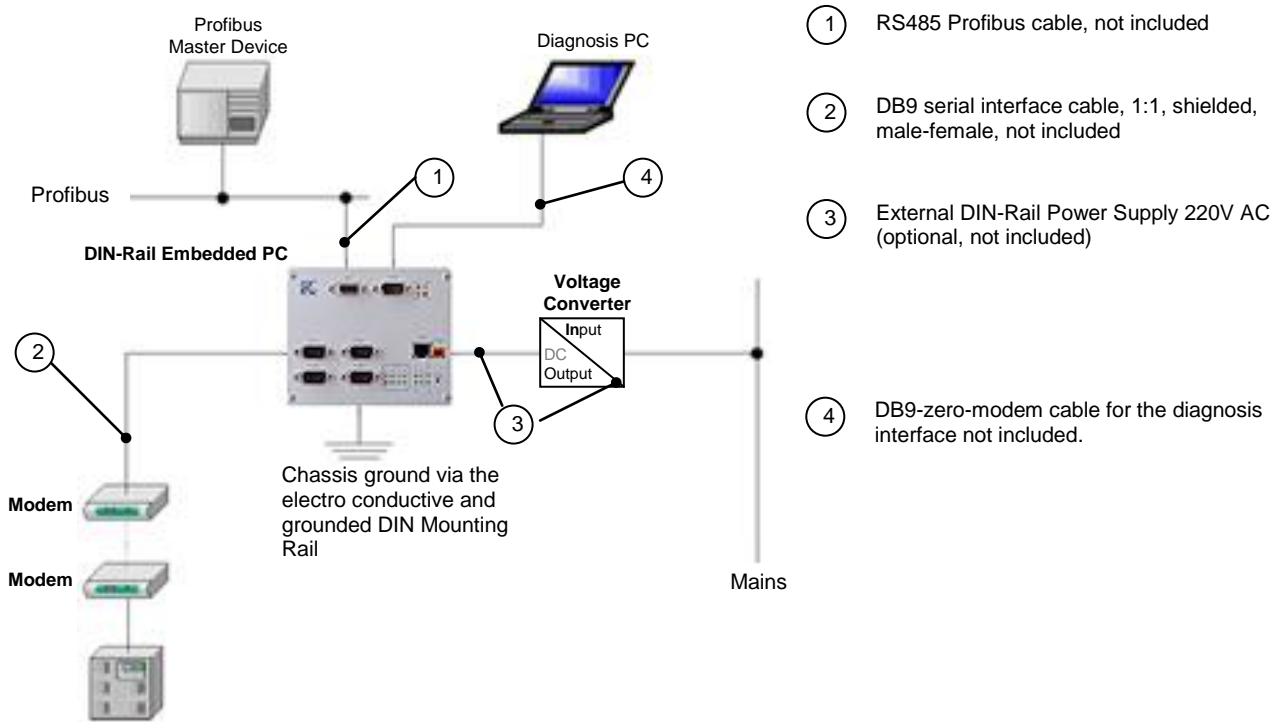

Fig. 2.4: Electrical Installation – Circuit Diagram

Before connecting the HECPM with the power supply it has to be made sure that the correct voltage is used. The operational voltage is stated onto the label sidewise of the HECPM.
Another voltage is available on request

Important: In order to comply with the regulations on electromagnetic compatibility data lines and the power supply cord must be as short as possible.

3.6 Maintenance

Generally the HECPM is maintenance-free.

Should it become necessary to exchange the CompactFlash or battery, proceed as follows:

Attention: Any transfer of charges to the printed circuit board (PCB) and components must be avoided.

1. Disconnect the HECPM from the mains, detach the data lines.
After dismounting as per point 2.3 remove the 4 housing screws on the front panel of the HECPM (Fig. 2.5.1 and 2.5.2).

2. Replacement of the CompactFlash / battery

2.1 Replacement of the CompactFlash

The CompactFlash can be pulled out and changed, now (Fig. 2.5.3).
The CompactFlash must be inserted true sided in the CompactFlash-holder (please observe the different slot width sidewise) over the pressure point until the CompactFlash is snapped in.

2.2 Replacement of the battery

- Please, remove the 4 screws as per Figure 2.5.4.
- Please, put the Profibus card in front of the front panel (Fig. 2.5.5).
- Now, the battery can be pulled out (Fig. 2.5.6).
Attention: The correct polarity has to be observed before the new battery is inserted (positive pole up side).
- Please, put the Profibus card back in the starting position and tighten the 4 screws (Fig. 2.5.7).

3. Push the PCB-unit back into the housing and tighten the 4 screws on the front panel (Fig. 2.5.8 and 2.5.9).
Please, observe the correct position (the spring bracket on the back of the housing must be up side).

4. After proper installation the HECPM can be put into operation again.

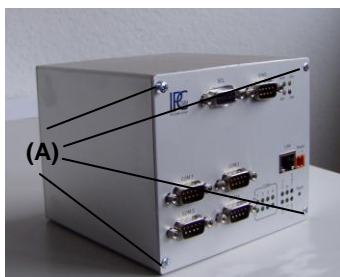

Fig. 2.5.1
Remove the front panel screws (A).



Fig. 2.5.2
Pull out front panel (B).

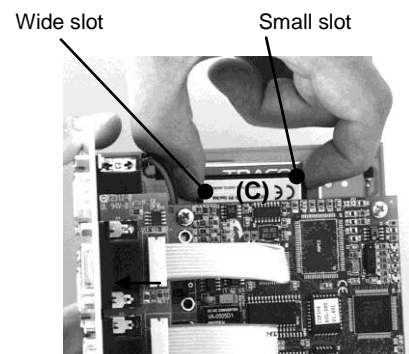

Fig. 2.5.3
Pull out the CompactFlash (C).

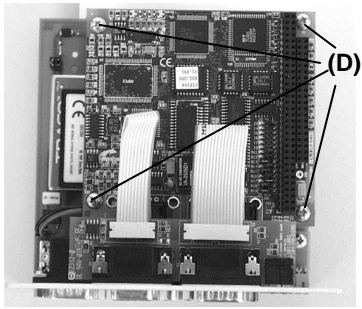

Fig. 2.5.4
Remove the 4 screws (D).

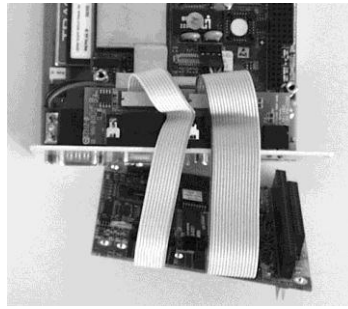

Fig. 2.5.5
Put the Profibus card in front of the front panel.

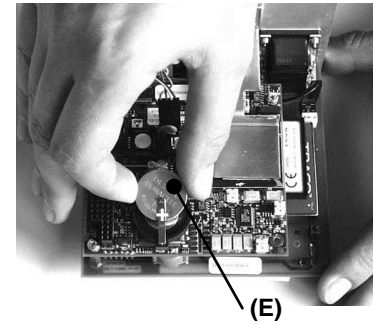

Fig. 2.5.6
Replace the battery (E).
Observe right polarity.

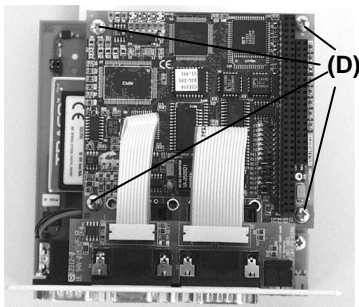

Fig. 2.5.7
Put the Profibus card back in the starting position and tighten the 4 screws (D).

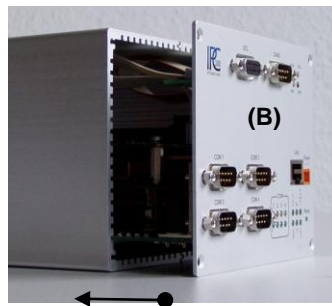

Fig. 2.5.8
Insert front panel (B) back into the housing.

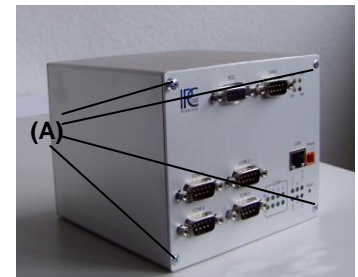
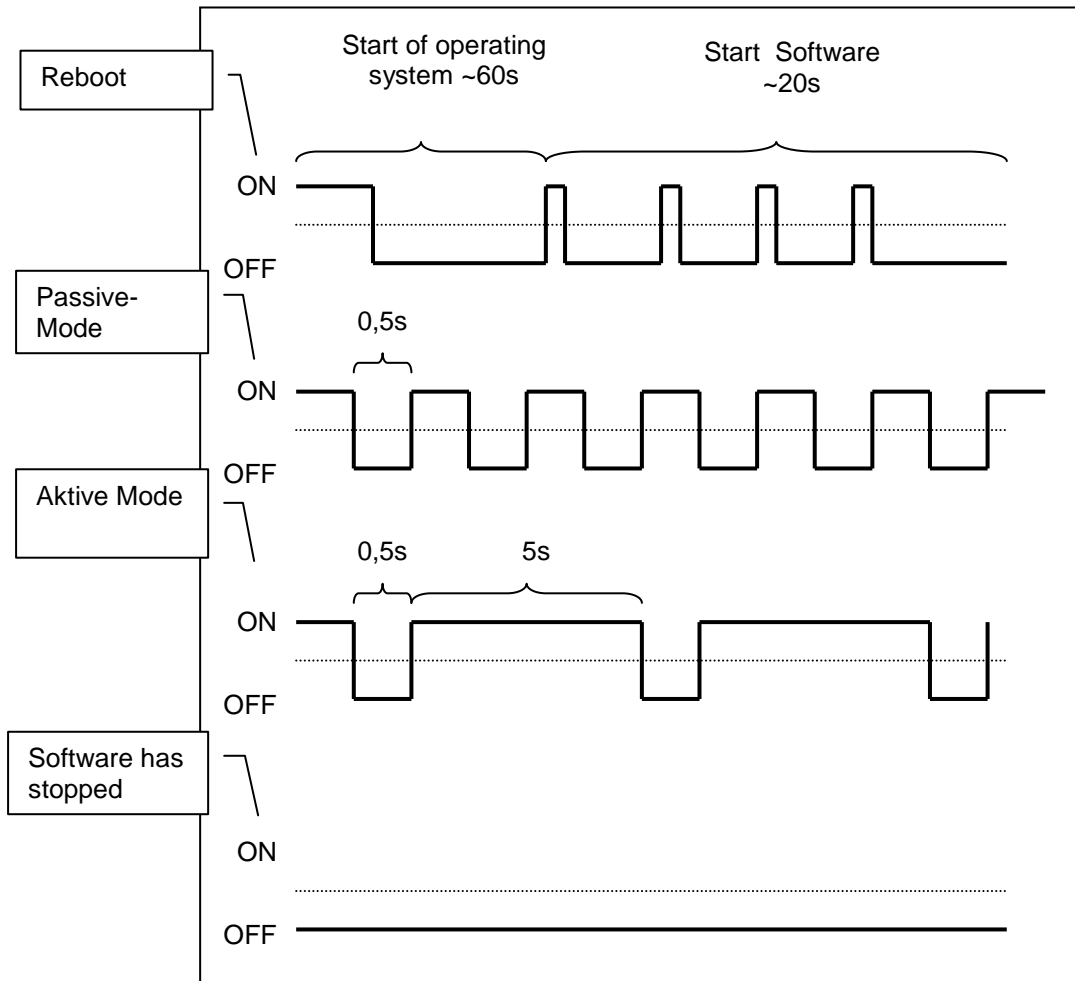





Fig. 2.5.9
Tighten the front panel screws (A).

3.7 CPU-Status LED

The CPU LED is used by the software to show different software conditions. Following figure shows all possible indications:



3.8 PROFIBUS-DP Master diagnostics LEDs

LED	State	Meaning
RDY  (yellow)	On	Device is ready
	Flashing irregular (*)	Hardware or heavy runtime error detected
	Off	Device has no power supply or hardware defect
	On	communication is running, the device has established at least one configured fieldbus connection
RUN  (green)	Flashing cyclic at 5 Hz	No error in configuration found, communication is stopped (ERR-LED red off) or ready for communication but no connection to any Slave (ERR-LED red on)
	Flashing irregular (*)	Power Up: Configuration missing or faulty, device needs commissioning, Runtime: Host Watchdog timeout
	Off	No Communication
ERR  (red)	On	Device has found a communication problem to at least one PROFIBUS-DP slave device (STA-LED on) or has detected a short circuit (STA-LED off)
	Off	No error
STA  (yellow)	On	Device is holding the PROFIBUS token and is able to transmit telegrams
	Flashing acyclic (**)	Device is sharing the PROFIBUS token with other master devices in the PROFIBUS network
	OFF	Device is not configured or has not received the Token permission on the PROFIBUS network

(*) 3 times fast at 5 Hz, 8 times between 0,5 Hz and 1 Hz

(**) between 0,5 Hz and 100 Hz

3.9 Scope of Delivery

- DIN-Rail Embedded PC (HECPM)

Optional:

External power supply 100-240 V AC (technical data see attached power supply instruction)

4 Appendix A – Technical Data Sheet

Technical Data Sheet

Processor

AMD ÉLAN SC520 / 133 MHz

Dynamic Memory

SDRAM max. 128 MByte, SO-DIMM

Interface

- 4 RS232 serial interface (COM 1 to COM 4) with surge protection
- 1 CAN-Bus, opto-isolated (optional)
- 1 Printer interface (LPT1) ¹⁾
- AT-IDE Hard-disk interface ¹⁾
- Compact Flash socket ¹⁾
- PC/104-Bus ¹⁾
- Floppy interface ¹⁾
- PS/2 mouse and keyboard interface ¹⁾
- 10BaseT-LAN interface
- PROFIBUS-DP Master PC/104 card
 - 9,6 Kbaud to 12 Mbaud
 - Interface : RS485, isolated, according EN 50170
 - Diagnostic Interface: RS232C, non isolated DSub male connector 9 pin
 - Slaves: max. 125
 - Input/Output: max. 244 Bytes per Slave
 - DPV1 Class1 / Class 2
 - Combi-Master: max. 7 KByte

Diagnosis

- Power LED
- Link and activity for LAN interface
- Transmit and receive Display Module for RS232 interfaces (COM 1 to COM 4)
- HDD LED
- LED to show different software conditions
- PROFIBUS (RDY, RUN, STA, ERR)

Additional Functions

- Battery buffered real time clock (RTC)
- Watchdog
- Reset

Mass Storage

- CompactFlash cartridge with up to 16 GB (MTBF ≥ 4.000.000h)

Power consumption

- 18 - 36 V DC / 8 W ²⁾

Standards

- CE

Housing

- Aluminum passivated, including clip for mounting on a 35 mm DIN-Rail

Dimensions (without clip)

- Width: 125 mm
- Height: 105 mm
- Depth: 120 mm

Operating Environment

- Environmental temperature/storage temperature: 0°C – 45°C / - 10°C – 70°C
- Relative humidity: 5 % to 90 % non-condensing

- 1) Interfaces aren't conducted in the housing
- 2) Voltage and power data depend on the used type

Note: Differences to the delivered type are possible.

5 Appendix B – Declaration of EEC Compliance

Declaration of EEC Compliance

For the following product

DIN-Rail Mounted PC (HECPM-CGC)

it is hereby confirmed that it complies with the main specifications laid down in the Council Guidelines on Harmonizing the Statutory Regulations of the Member States for Electromagnetic Compatibility (89/336/EEC).

Any changes to the said DIN-Rail Mounted PC (HECPM) not authorized by this company invalidates this declaration.

The evaluation of this product for electromagnetic compatibility was carried out in accordance with the following standards

EN 55022/1998
EN 50082-2/1995

Place/Date/Manufacturer signature: Erlangen, 11.04.2008

Position of signatory: Managing Director, Artur Votteler