

HECPS

General Operating, Maintenance and Installation Manual



DIN-Rail Embedded PC / Profibus



IPCOMM GmbH

Gundstraße 15
91056 Erlangen
Germany

Phone: +49 9131 92076-0
Fax: +49 9131 92076-10
Internet: <http://www.ipcomm.de>
Email: info@ipcomm.de

Edition May 2012
Version 1.1.6



DIN EN ISO 9001:2008
Zertifikat: 01 100 040757

1 Contents

1	CONTENTS.....	1
2	INTRODUCTION.....	2
3	DEVICE PRESENTATION	3
3.1	Rail-mounted Embedded PC HEC.....	3
3.2	Nomenclature.....	3
3.3	Operation.....	4
3.4	Mounting and Dismounting.....	5
3.5	Electrical Installation – Circuit Diagram.....	6
3.6	Maintenance.....	7
3.7	CPU-Status LED.....	9
3.8	PROFIBUS-DP Slave diagnostics LEDs.....	10
3.9	Scope of Delivery.....	10
4	APPENDIX A – TECHNICAL DATA SHEET	11
5	APPENDIX B – DECLARATION OF EEC COMPLIANCE	14

2 Introduction

All technical information, specifications and illustrations contained in this Operating, Maintenance and Installation Manual remain our property and shall not be used otherwise than for operating this installation, nor shall they be copied, reproduced or passed on to third parties or brought to their notice without our prior written consent.

The information represented in this manual is in keeping with current standards and is subject to later alterations.

This manual contains important instructions referring to safe installation, commissioning, operation and maintenance.

Read this manual carefully before starting up the DIN-Rail Embedded PC (HECPS) - also called as DIN-Rail Mounted PC - and observe the instructions.

It is to be noted that the HECPS has not been protected against lightning and the operator should, *if desired*, take appropriate protective precautions.

Caution!

The HECPS is a class A device. This device can cause radio disturbances in residential buildings. In this case the operator might be obliged to carry out appropriate measures and take responsibility.

At this point we want to draw your attention to the fact that any warranties with respect to the delivered goods will be invalid in the event that:

- (1) Operation, servicing and maintenance are not carried out accurately according to the instructions; repairs are not carried out by our personnel or without our prior written consent.
- (2) Commissioning is not carried out by our personnel or we have not given our approval for the commissioning or the commissioning is carried out by untrained personnel.
- (3) The unit is used inadequately, incorrectly, negligently or inappropriately or for a purpose other than that originally intended.
- (4) The serial number is removed from the product.

3 Device Presentation

3.1 Rail-mounted Embedded PC HEC

The rail-mounted PC HEC has been specially designed for industrial applications and serves as hardware platform for the protocol converter

The HEC basic version is fitted with a PC/104 CPU module and offers serial RS232 interfaces as well as an Ethernet adapter.

The rail-mounted PC contains no rotating components.

Thanks to the low power requirements a cooling fan is not necessary. A Compact Flash memory card with an MTBF $\geq 1.000.000$ h serves as a storage medium.

Integrated LEDs support various diagnosis functions. Indicators for the input voltage, send and receive status of the RS232 interfaces and the network controller report the current operating status.

A CAN controller can be installed directly on the PC/104 CPU module. In addition, the rail-mounted PC can be upgraded with various PC/104 modules and thus integrated in various fieldbus systems.

3.2 Nomenclature

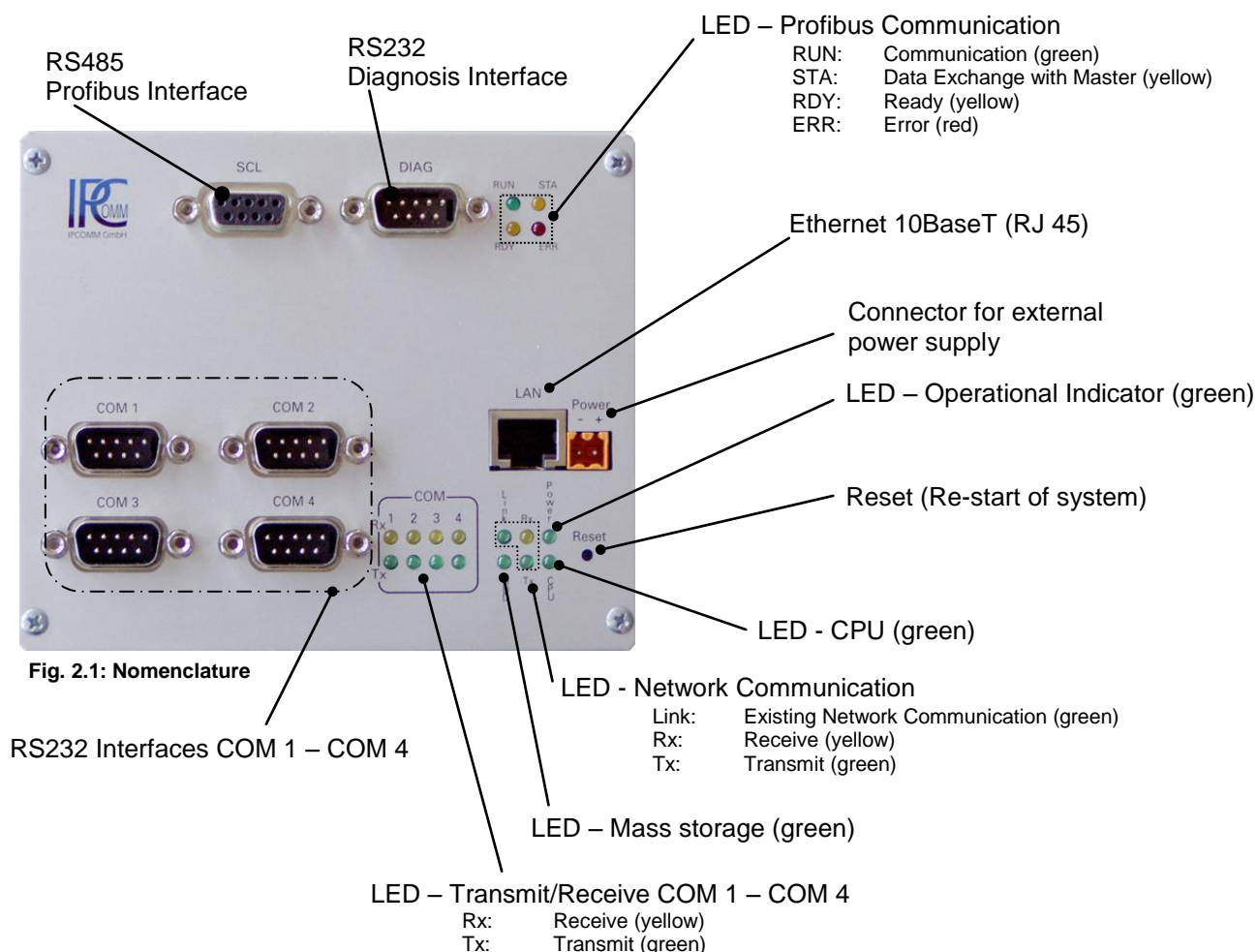

3.3 Operation

The HECPS is designed for the assembling on a 35 mm DIN-Mounting Rail.

The HECPS is supplied with 5 V DC. The external DC/DC converter unit 24 V DC input (35 mm DIN-Mounting) is included. Other input voltages are optional available (e.g. + 48 V und + 60 V DC).

Before connecting the HECPS with the power supply it has to be made sure that the correct voltage is used. The operational voltage is stated onto the label sidewise of the HECPS.

In order to maintain operation large temperature fluctuations must be avoided. The HECPS mustn't be exposed solar radiation.

An air-conditioned environment is to be recommended for operating the HECPS.

Interference sources like power inverters and power cables close to the HECPS should be avoided.

The following operating conditions are to be observed for interference-free operation:

- Environmental temperature: 0°C – 45°C
- Relative humidity: 5 % - 90 % **non-condensing**
- Installation site and environmental conditions should comply with the corresponding degree of protection (IP 40).
The housing isn't protected against the penetration of water!
- The supply voltage (see label) must correspond with the stated operational data.
It must be ensured that excessive voltage fluctuations in the power supply are avoided.
- Mounting on electro conductive and grounded DIN-Mounting Rail.

Note: Excessive voltages affecting the HECPS directly via the supply voltage or indirectly via data lines, power line or flashovers might cause damage to the HECPS.
Interference of this kind must be prevented.

Important: If a external power supply is delivered by IPCOMM GmbH the instructions can be found in the enclosed operating manual.

Further operating instructions depend on the kind and number of the installed components and on the operating system. The relevant information can be found in the project-specific or product-specific manual.

The operating and control elements are located on the front side, Fig. 2.1.

3.4 Mounting and Dismounting

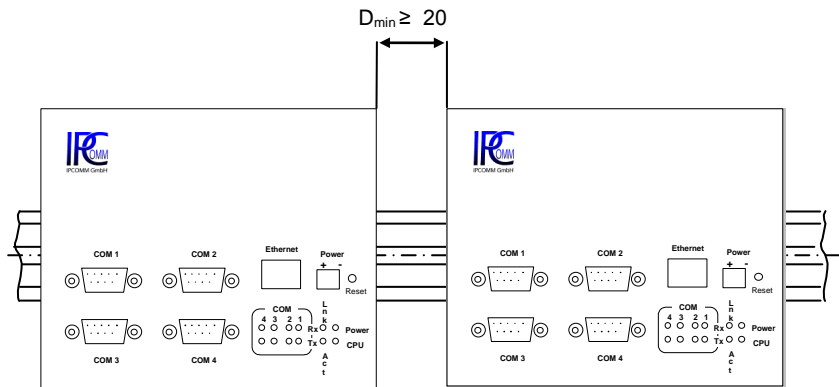

A minimum distance D_{min} needs to be observed if several HECPSs are to be installed in a row.

The assembling has to be occurred in accordance with figure 2.3.1.

Fig. 2.3.1: Assembling

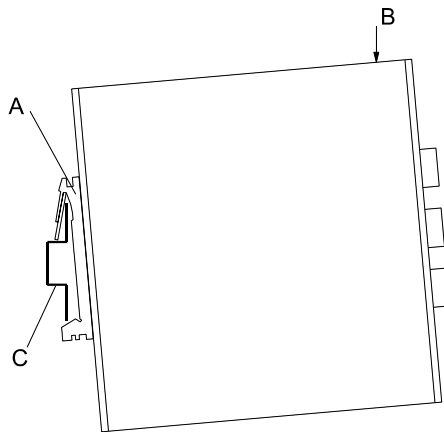

The HECPS is mounted on a 35 mm DIN-Mounting Rail.

As per figure 2.3.2 opposite, clip A is put on to the DIN-Mounting Rail C.

By pressing in the direction of the marked point B the HECPS snap into place.

The ground connection is completed via clip A directly to the DIN-Mounting Rail.

It must be ensured that the DIN-Mounting Rail is electro conductive and grounded.

Fig. 2.3.2 Mounting

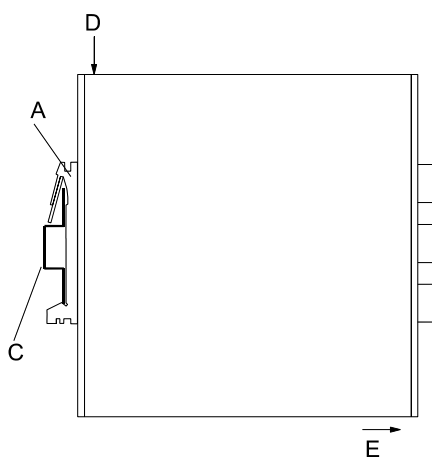

For dismounting, press in the direction of the marked point D while pulling at the bottom of the HECPS in direction E, figure. 2.3.3.

Fig. 2.3.3: Dismounting

3.5 Electrical Installation – Circuit Diagram

The HECPS must be connected as per the following circuit diagram, Fig. 2.4.

Dependent on the application the circuit may be different from the shown one.

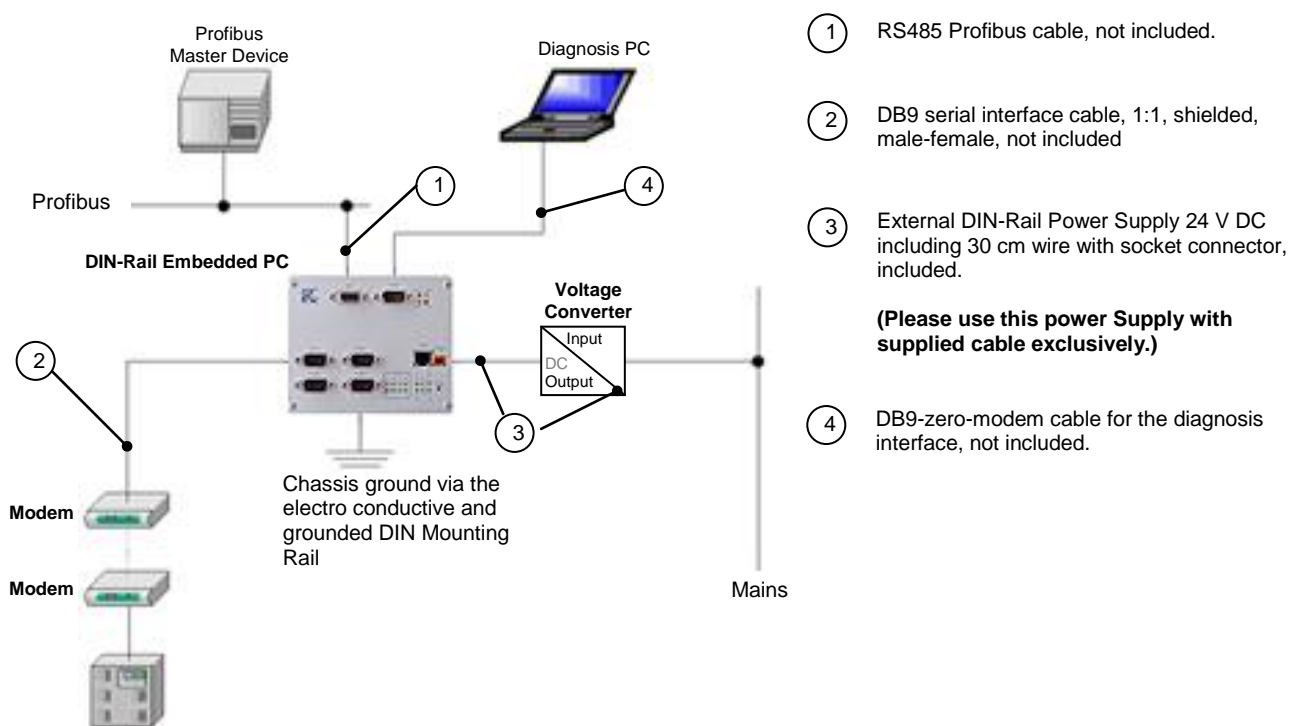

Fig. 2.4: Electrical Installation – Circuit Diagram

Before connecting the HECPS with the power supply it has to be made sure that the correct voltage is used. The operational voltage is stated onto the label sidewise of the HECPS. In scope of delivery is DIN-Rail power supply with 24 V DC input and output wire included.

(Please use this power Supply with supplied cable exclusively.)

Another voltage is available on request

Important: In order to comply with the regulations on electromagnetic compatibility data lines and the power supply cord must be as short as possible.

3.6 Maintenance

Generally the HECPS is maintenance-free.

Should it become necessary to exchange the CompactFlash or battery, proceed as follows.

Attention: Any transfer of charges to the printed circuit board (PCB) and components must be avoided.

1. Disconnect the HECPS from the mains, detach the data lines.
After dismounting as per point 2.3 remove the 4 housing screws on the front panel of the HECPS (Fig. 2.5.1 and 2.5.2).

2. Replacement of the CompactFlash / battery

2.1 Replacement of the CompactFlash

The CompactFlash can be pulled out and changed, now (Fig. 2.5.3).
The CompactFlash must be inserted true sided in the CompactFlash-holder (please observe the different slot width sidewise) over the pressure point until the CompactFlash is snapped in.

2.2 Replacement of the battery

- Please, remove the 4 screws as per Figure 2.5.4.
- Please, put the profibus card in front of the front panel (Fig. 2.5.5).
- Now, the battery can be pulled out (Fig. 2.5.6).

Attention: The correct polarity has to be observed before the new battery is inserted (positive pole up side).

- Please, put the profibus card back in the starting position and tighten the 4 screws (Fig. 2.5.7).

3. Push the PCB-unit back into the housing and tighten the 4 screws on the front panel (Fig. 2.5.8 and 2.5.9).

Please, observe the correct position (the spring bracket on the back of the housing must be up side).

4. After proper installation the HECPS can be put into operation again.

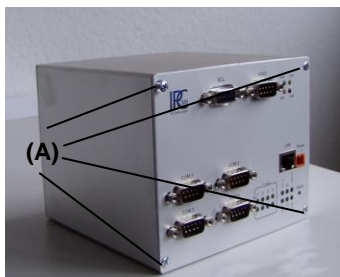

Fig. 2.5.1
Remove the front panel screws (A).



Fig. 2.5.2
Pull out front panel (B).

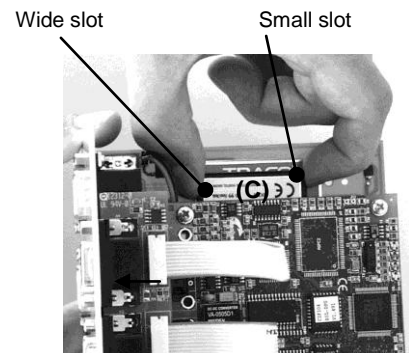

Fig. 2.5.3
Pull out the CompactFlash (C).

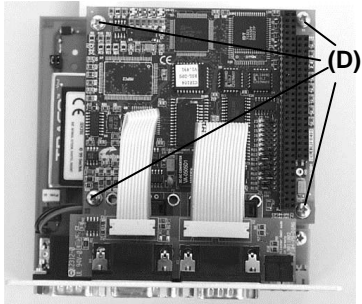

Fig. 2.5.4
Remove the 4 screws (D).

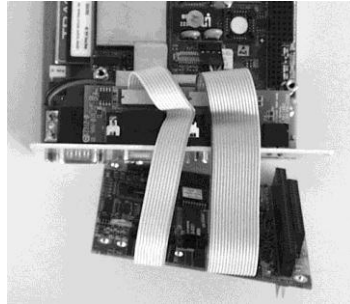

Fig. 2.5.5
Put the profibus card in front of the front panel.

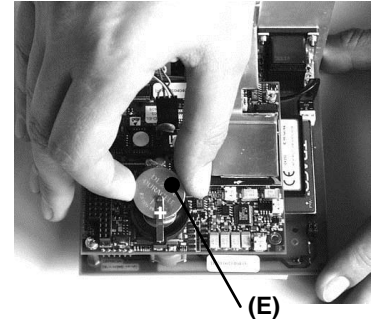

Fig. 2.5.6
Replace the battery (E).
Observe right polarity.

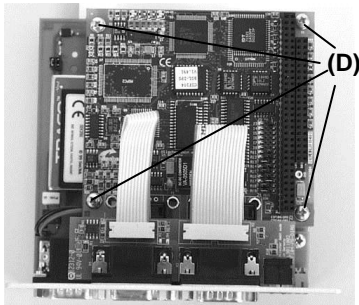

Fig. 2.5.7
Put the profibus card back in the starting position and tighten the 4 screws (D).

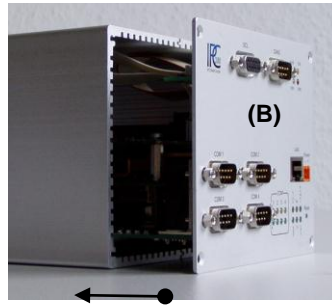

Fig. 2.5.8
Insert front panel (B) back into the housing.

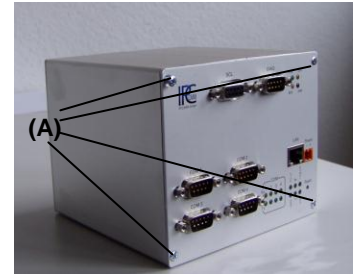
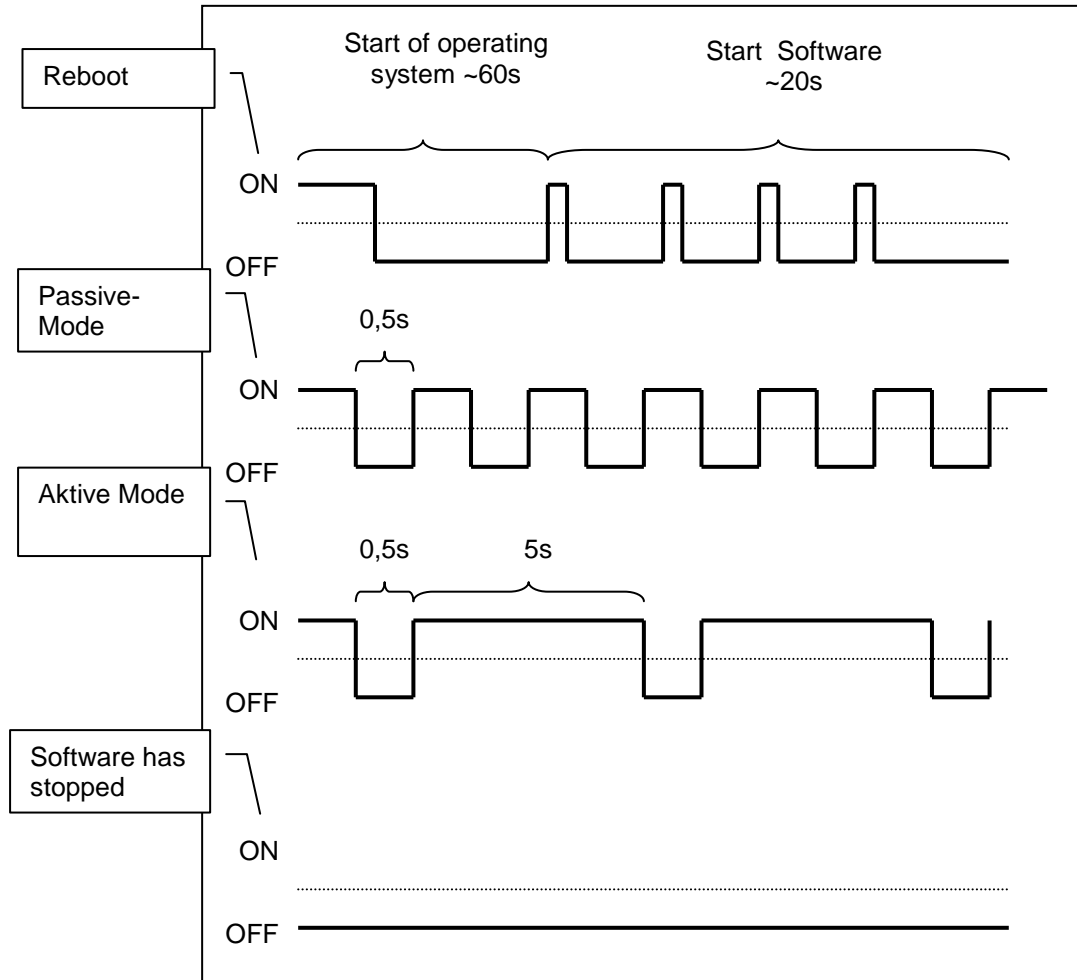





Fig. 2.5.9
Tighten the front panel screws (A).

3.7 CPU-Status LED

The CPU LED is used by the software to show different software conditions. Following figure shows all possible indications:



3.8 PROFIBUS-DP Slave diagnostics LEDs

LED	State	Meaning
RDY  (yellow)	On	Device is ready
	Flashing irregular (*)	Hardware or heavy runtime error detected
	Off	Device has no power supply or hardware defect
RUN  (green)	On	Slave in cyclic data exchange with PROFIBUS-DP Master
	Flashing irregular (*)	Power Up: Configuration missing or faulty, device needs commissioning, Runtime: Host Watchdog timeout
	Off	No Communication
ERR  (red)	On	application program (communication mode: bus synchronous / device controlled) not longer synchronous to bus cycle
	Off	No error
STA  (yellow)	On	Slave has received parameter data / configuration data from the DP Master and has reached the state data exchange
	OFF	Slave has not reached the state data exchange

(*)3 times fast at 5 Hz, 8 times between 0,5 Hz and 1 Hz

3.9 Scope of Delivery

- DIN-Rail Embedded PC (HECPS)
- External DIN-Rail Power Supply 24 V DC including 30 cm wire (from Power supply to DIN-Rail Embedded PC (HECPS)) with socket connector BL3,5
(Please use this power Supply with supplied cable exclusively.)

Optional:

External power supply 100-240 V AC (technical data see attached power supply instruction)

4 Appendix A – Technical Data Sheet

Technical Data Sheet

Processor

AMD ÉLAN SC520 / 133 MHz

Dynamic Memory

SDRAM max. 128 MByte, SO-DIMM

Interfaces

- 4 RS232 serial interfaces (COM 1 to COM 4) with surge protection
- 1 CAN-Bus, opto-isolated (optional)
- 1 printer interface (LPT1) ¹⁾
- AT-IDE harddisk interface ¹⁾
- CompactFlash socket ¹⁾
- PC/104-Bus ¹⁾
- Floppy interface ¹⁾
- PS/2 mouse and keyboard interface ¹⁾
- 10BaseT-LAN-interface
- PROFIBUS-DP Slave interface
 - 9,6 KBaud to 12 MBaud
 - Interface: RS485, isolated, according EN50170
 - Diagnostic interface: RS-232C, non-isolated DSub male connector 9 pin
 - Slaves: max. 125
 - Input/output: max. 244 Bytes per Slave
 - DPV1 Class1 / Class 2
 - Combi-Master: max. 7 KByte

Diagnosis

- Power LED
- Link and activity for LAN interface
- Transmit and receive Display Module for RS232 interfaces (COM 1 to COM 4)
- HDD LED
- LED to show different software conditions
- PROFIBUS (RDY, RUN, STA, ERR)

Additional Functions

- Battery buffered real time clock (RTC)
- Watchdog
- Reset

Mass Storage

- CompactFlash cartridge with up to 16 GB (MTBF ≥ 1.000.000h)

Power Consumption

- 18 – 36 V DC / 8 W ²⁾

Standards

- CE

Housing

- Aluminum passivated, incl. clip for mounting on a 35 mm DIN-Rail

Dimensions (with clip)

- Width: 125 mm
- Height: 105 mm
- Depth: 120 mm

Operating Environment

- Environmental temperature/storage temperature: 0°C – 45°C / - 10°C – 70°C
- Relative humidity: 5 % to 90 % non-condensing

Subject to alterations

Version: 1.1.6

- 1) Interfaces aren't conducted in the housing.
- 2) Voltage and power data depend on the used type

Note: Differences to the delivered type are possible!

5 Appendix B – Declaration of EEC Compliance

Declaration of EEC Compliance

For the following product

DIN-Rail Mounted PC (HECPS-CGC)

it is hereby confirmed that it complies with the main specifications laid down in the Council Guidelines on Harmonizing the Statutory Regulations of the Member States for Electromagnetic Compatibility (89/336/EEC).

Any changes to the said DIN-Rail Mounted PC (HECPS) not authorized by this company invalidates this declaration.

The evaluation of this product for electromagnetic compatibility was carried out in accordance with the following standards

EN 55022/1998
EN 50082-2/1995

Place/Date/Manufacturer signature: Erlangen, 21.01.2004

Position of signatory: Managing Director, Artur Votteler